

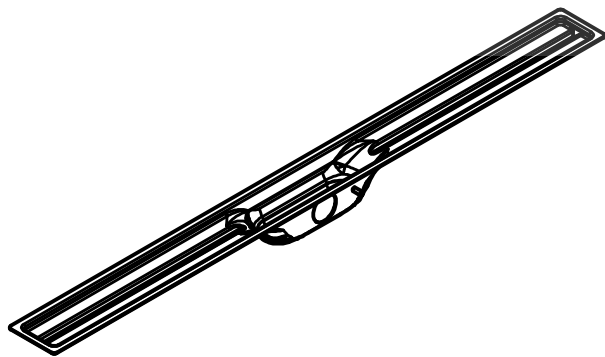

A-A (1/3)

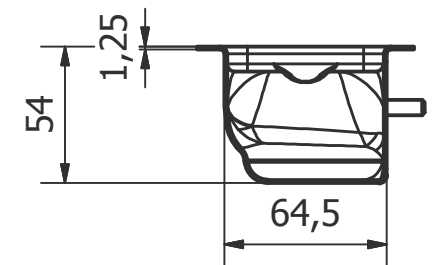

THIS DOCUMENT CONTAINS CONFIDENTIAL AND PROPRIETARY INFORMATION THAT CANNOT BE REPRODUCED OR DIVULGED IN WHOLE OR IN PART, WITHOUT WRITTEN AUTHORIZATION FROM GROUP NIVELLES N.V.

		www.i-drain.com Ambachtsweg 14 3890 Gingelom Belgium T +32 (0) 11 68 96 68 F +32 (0) 11 68 50 86		
		PROJECT:ID4E1001X20	Tol: +/-ISO-2768-C	Datum: 2/12/2014
Omschrijving:ID4E1001X20		Tekenaar: Roel	Materiaal: RVS	1/6
Goedkeuring:		Tekening:ID4E1001X20.dwg		Rev.0