

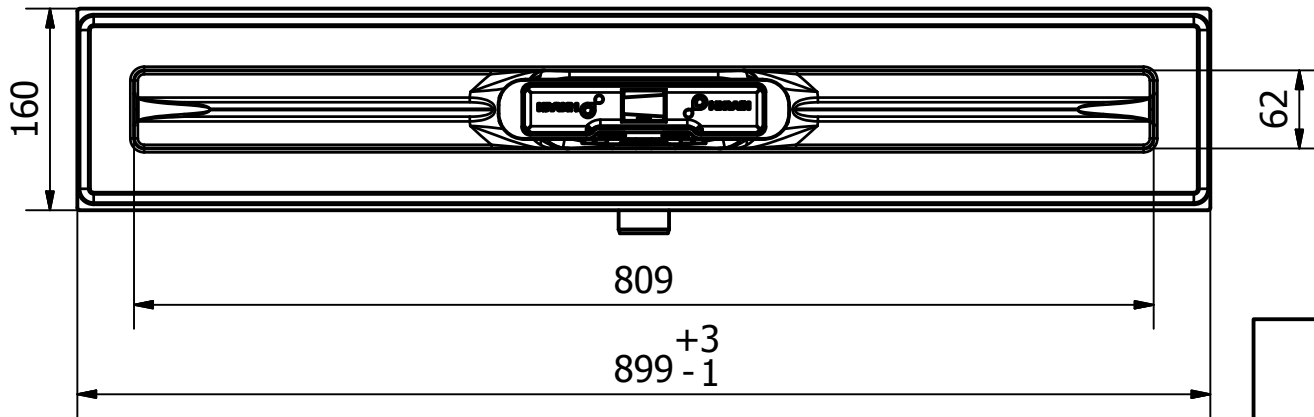

A-A (1/2)

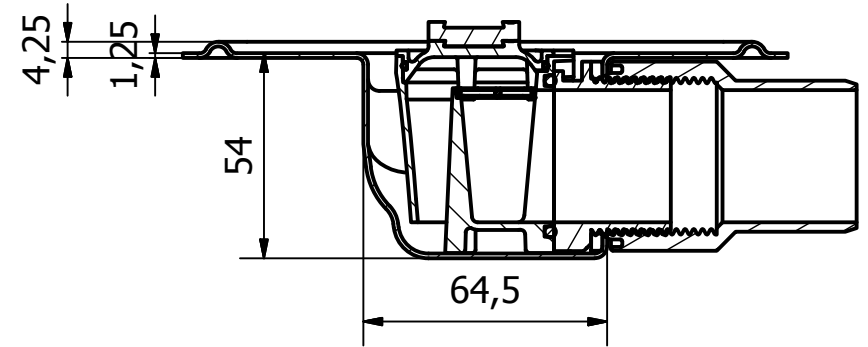

		www.i-drain.com Ambachtsweg 14 3890 Gingelom Belgium T +32 (0) 11 68 96 68 F +32 (0) 11 68 50 86		
		PROJECT:IP4MSD08001X1	Tol: ISO-2768-C	Datum: 2/03/2018
Omschrijving:IP4MSD08001X1		Tekenaar: Jonas	Materiaal:	Schaal: 1/6
Goedkeuring:		Tekening:IP4MSD08001X1.dwg		Rev.1