

Overall tolerance
 0-100 +/- 0.5
 100-500 +/- 1
 500-1000 +/- 1.5

A-A (1/2)

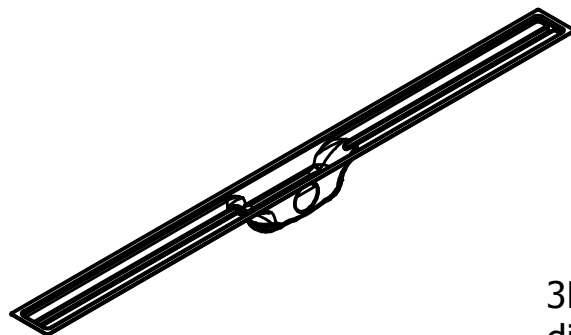

3D model is leading not mentioned dimensions following overall tolerance of NEN-ISO 2768-1 class m

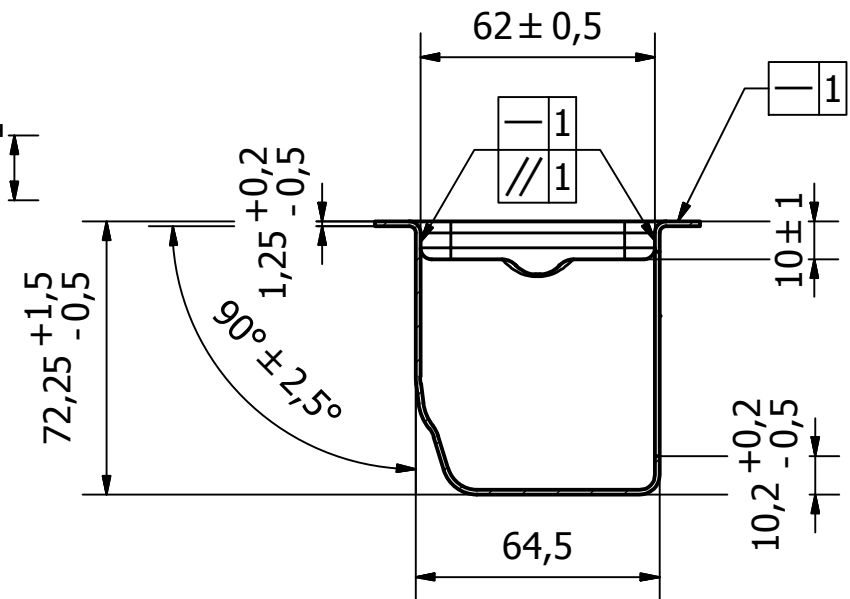
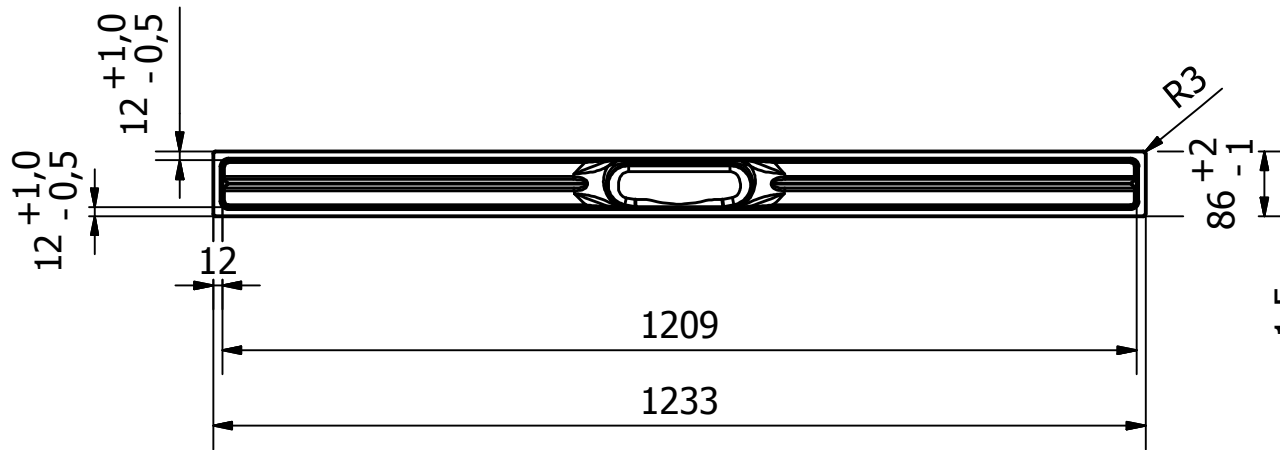

Group Nivelles N.V.
 Ambachtsweg 14
 3890 Gingelom
 Tel: +32 (0) 11 68 96 68
 Fax: +32 (0) 11 68 50 86
 E-mail: info@groupnivelles.com

GROUP
 NIVELLES

PROJECT:ID5M12001X1	Tol: ISO-2768-C	Datum: 1/04/2016	A4
Omschrijving:ID5M12001X1	Tekenaar: Roel	Materiaal: RVS 316	Schaal: 1/10
Goedkeuring:	Tekening:ID5M12001X1.dwg		Rev.2