

Overall tolerance
 0-100 +/- 0.5
 100-500 +/- 1
 500-1000 +/- 1.5

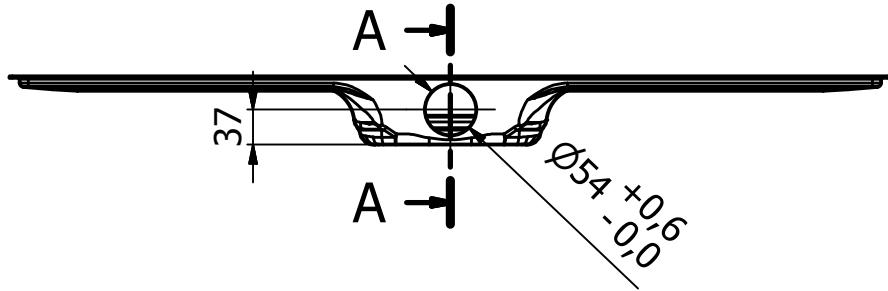

A-A (1/2)

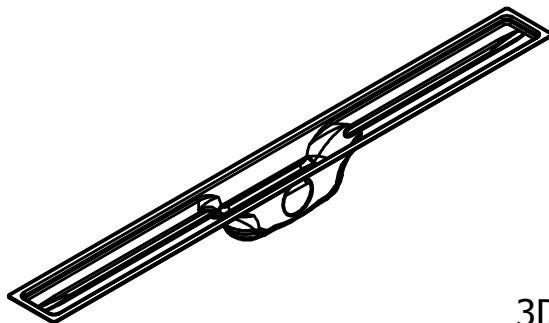
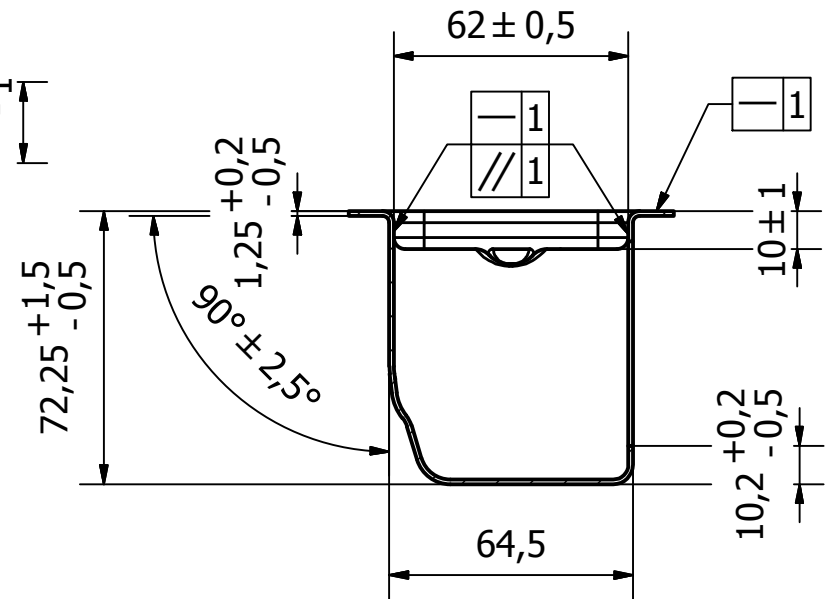
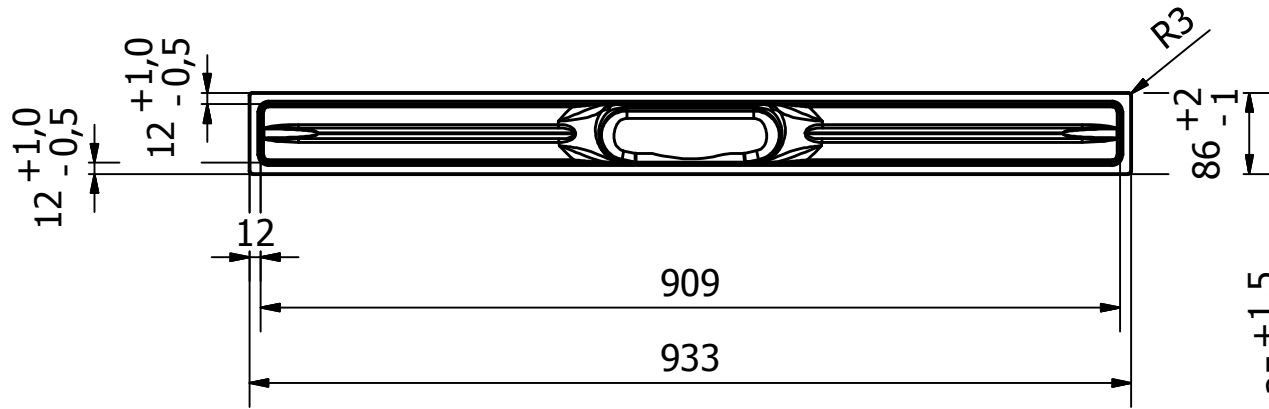

3D model is leading not mentioned
 dimensions following overall
 tolerance of NEN-ISO 2768-1 class m

		Group Nivelles N.V. Ambachtsweg 14 3890 Ginkelom Tel: +32 (0) 11 68 96 68 Fax: +32 (0) 11 68 50 86 E-mail: info@groupnivelles.com		GROUP NIVELLES	
PROJECT:ID5M09001X1	Tol: ISO-2768-C	Datum: 1/04/2016	A4		
Omschrijving:ID5M09001X1	Tekenaar: Roel	Materiaal: RVS 316	Schaal: 1/8		
Goedkeuring:	Tekening:ID5M09001X1.dwg		Rev.2		