

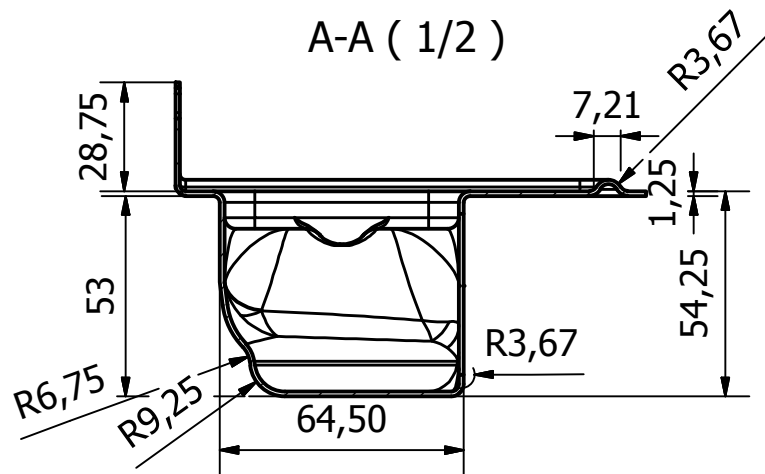

A-A (1/2)



 Ambachtsweg 14 3890 Gingelom www.I-DRAIN.com Tel: +32 (0) 11 68 96 68 Fax: +32 (0) 11 68 50 86 info@i-drain.com			
PROJECT:ID4ZSM09001X1	Tol: +/-ISO 2768-C	Datum:6/09/2011	A4
Omschrijving:ID4ZSM09001X1	Tekenaar:frederik	Aantal:	1/5
Goedkeuring:	Tekening:ID4ZSM09001X1.DWG		Rev.1